

A7 SPORTBACK (4KA)

10/2017 ->

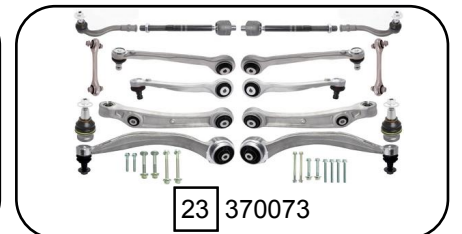
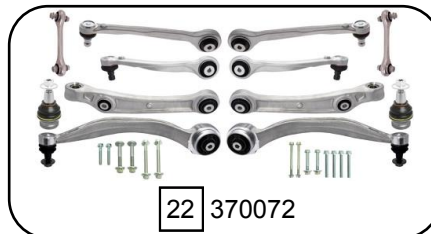
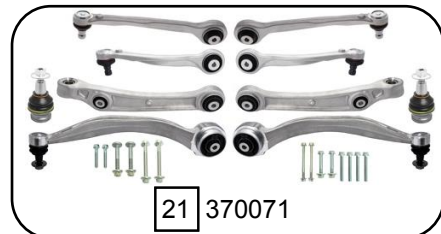
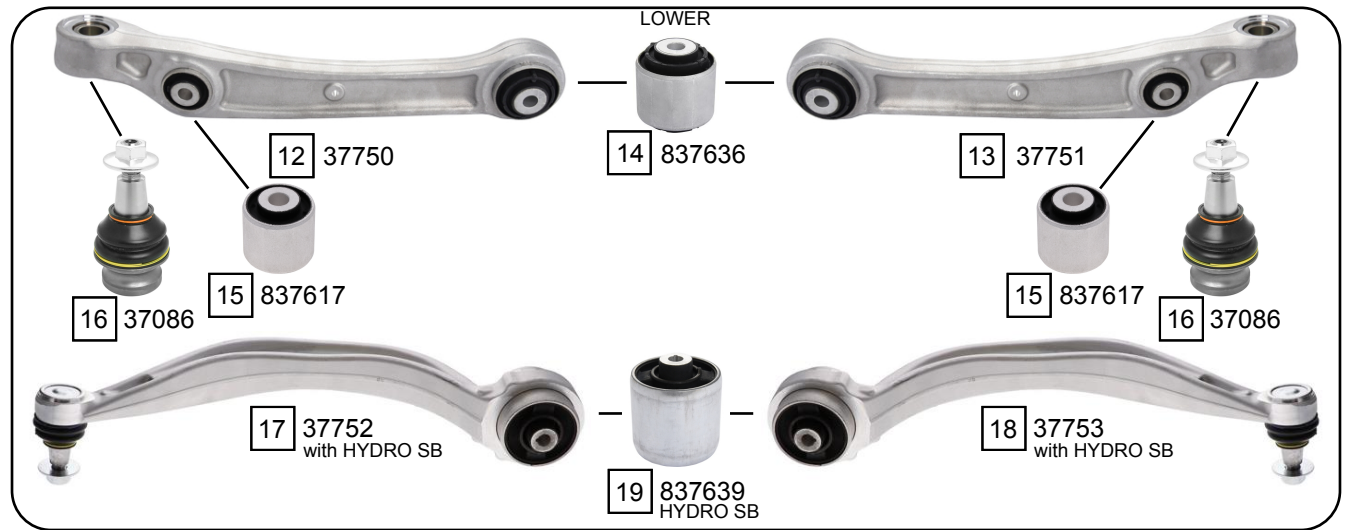
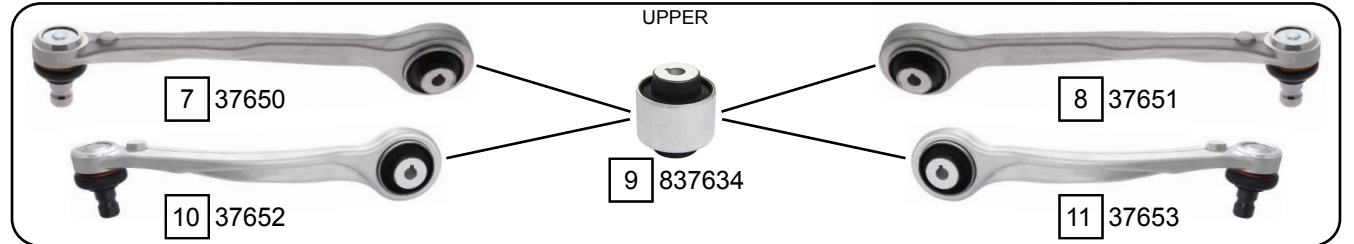
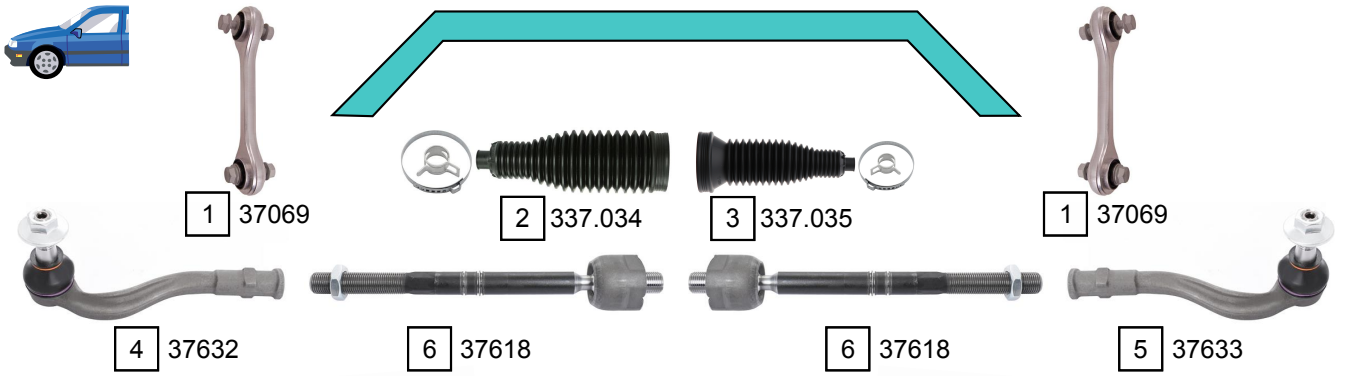

Ref.	Sidem Ref.	Description	OE-number	Measures	Ref.	Sidem Ref.	Description	OE-number	Measures
1	37069	stabilizer link	4M0 411 317	L:170	13	37751	TCA right wobj	4K0 407 152	c:19.4 L:374
2	337.034	steering rack gaiter	4M0 423 831 B	D:57 d:16 L:203	14	837636	silentblock for TCA	4M0 407 182 A	di:12.1 do:55.2
3	337.035	steering rack gaiter	4M0 423 832 B	D:80 d:16 L:219	15	837617	silentblock for TCA	4E0 407 181 B	di:12.3 do:43.8
4	37632	tie rod end left	8W0 423 811 C	c:15.8 th:FM16X1.5R	16	37086	ball joint	80A 407 689 C	c:20 do:46
5	37633	tie rod end right	8W0 423 812 C	c:15.8 th:FM16X1.5R	17	37752	TCA left wbj	80A 407 693 E	c:18.1
6	37618	axial joint	4M0 423 810 C	th:MM16X1.5R L:235	18	37753	TCA right wbj	80A 407 694 E	c:18.1
7	37650	TCA left wbj	4M0 407 505 B	c:18	19	837639	silentblock for TCA	4K0 407 183	di:12.2 do:74.8
8	37651	TCA right wbj	4M0 407 506 B	c:18	20	37006	mounting kit	WHT 006 542 S1	
9	37652	TCA left wbj	4M0 407 509 B	c:18	21	370071	set TCA	80A 407 693 E S1	
10	37653	TCA right wbj	4M0 407 510 B	c:18	22	370072	set TCA + stab. link	80A 407 693 E S2	
11	837634	silentblock for TCA	4M0 407 515 A	di:10.2 do:46.3	23	370073	set TCA + stab. link + tr	80A 407 693 E S3	
12	37750	TCA left wobj	4K0 407 151	c:19.4 L:374					