

X4 (G02)

04/2018 ->

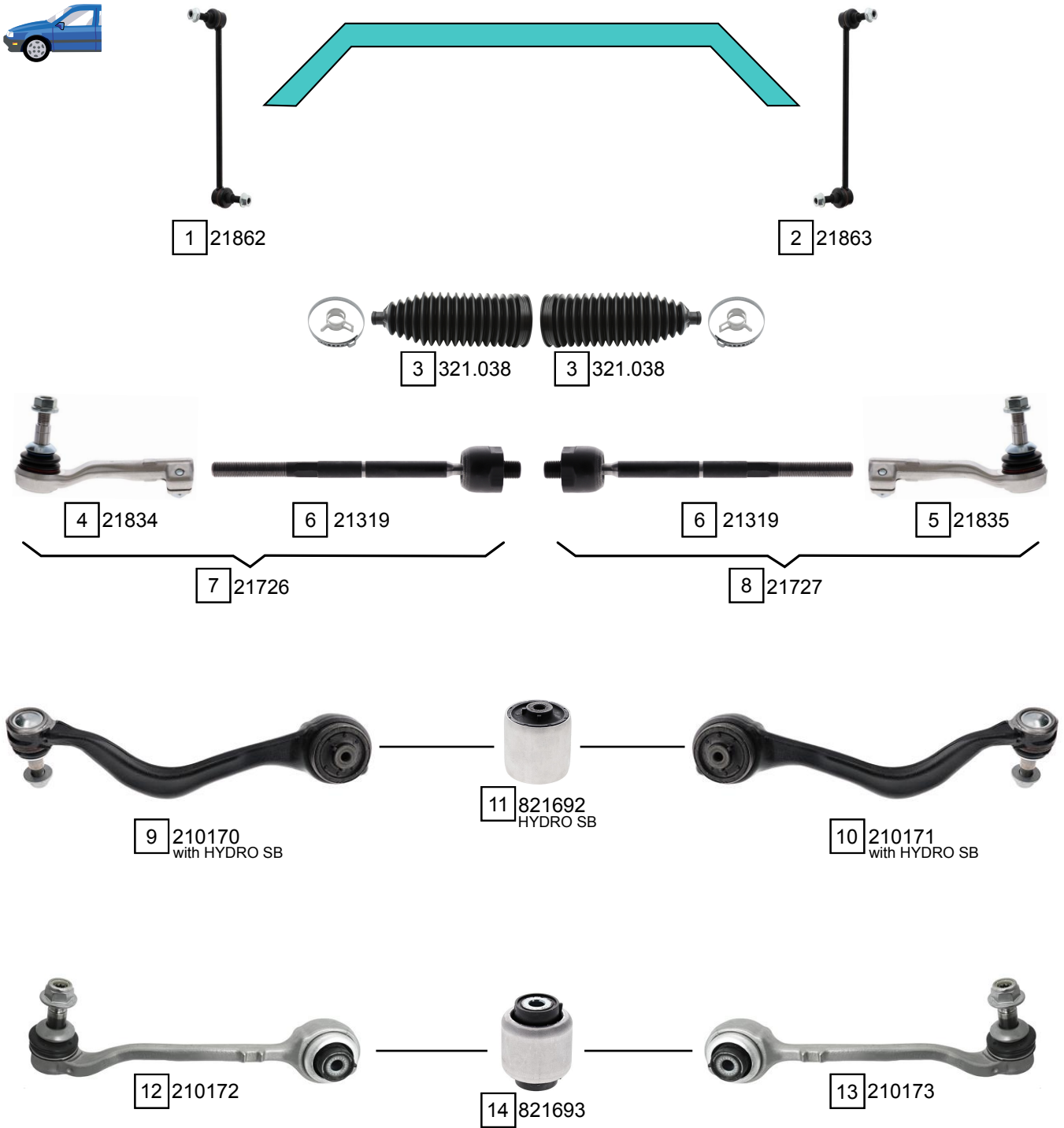

Ref.	Sidem Ref.	Description	OE-number	Measures	Ref.	Sidem Ref.	Description	OE-number	Measures
1	21862	stabilizer link left	31 35 6 887 271	L:316	8	21727	tie rod right	32 10 6 871 892	c:16.2
2	21863	stabilizer link right	31 35 6 887 272	L:316	9	210170	TCA left wbj	31 10 8 854 989	c:19.1 L:375
3	321.038	steering rack gaiter	32 10 6 871 895	D:60 d:13 L:193	10	210171	TCA right wbj	31 10 8 854 990	c:19.1 L:375
4	21834	tie rod end left	32 10 6 871 889	c:16.2 th:FM14X1.5R	11	821692	silentblock for TCA	Part of	di:12.1 do:75.5
5	21835	tie rod end right	32 10 6 871 893	c:16.2 th:FM14X1.5R	12	210172	TCA left wbj	31 30 8 865 615	c:19.1 L:295
6	21319	axial joint	Part of	th:MM16X1.5R L:252	13	210173	TCA right wbj	33 30 8 865 616	c:19.1 L:295
7	21726	tie rod left	32 10 6 871 884	c:16.2	14	821693	silentblock for TCA	Part of	di:12.1 do:56