

PANDA (141,241,153,253)

03/1980 - 07/2004

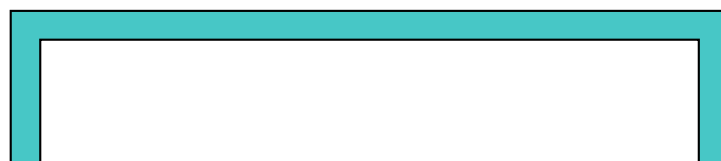
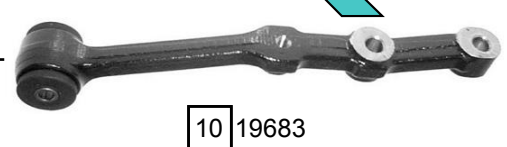
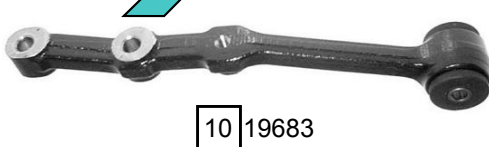
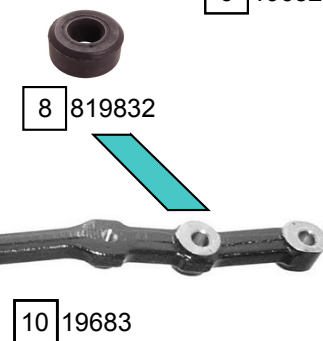
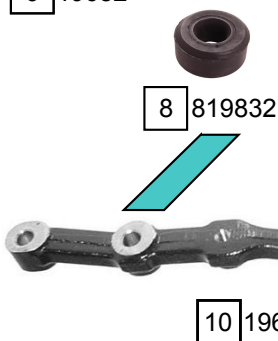
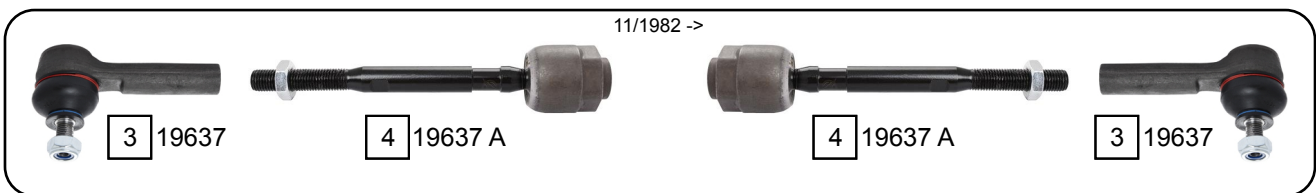
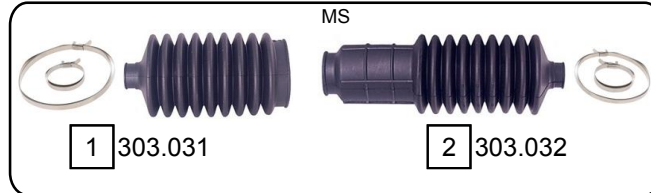

Ref.	Sidem Ref.	Description	OE-number	Measures	Ref.	Sidem Ref.	Description	OE-number	Measures
1	303.031	steering rack gaiter	437 11 55	D:42 d:10 L:125	6	19682	ball joint lower	440 26 44	c:12.2 do:37
2	303.032	steering rack gaiter	437 11 56	D:26 d:10 L:165	7	19670	TCA wbj	599 55 03	c:12.2
3	19637	tie rod end	596 08 35	c:12 th:FM12X1.5R	8	819832	stabilizer mounting	444 81 32	di:16.5
4	19637 A	axial joint	596 03 21	th:FM14X1.5R L:192	9	819630	silentblock for TCA	Part of	di:13.7 do:27.1
5	R10077	mounting tool ring ø42 ø34	TOOL	di:34 do:42	10	19683	TCA wobj	760 12 61	c:12